

# Product Data Sheet Item No. 4825-050/200

## Custom-made Steel Wire Net (by the m<sup>2</sup>)

Schutznetze24 GmbH  
Weyerberg 5, DE-35614 Aßlar-Berghausen  
Phone: +49 (0) 6443 - 436 96 40  
Mail: office@safetynet365.com  
Web: www.safetynet365.com

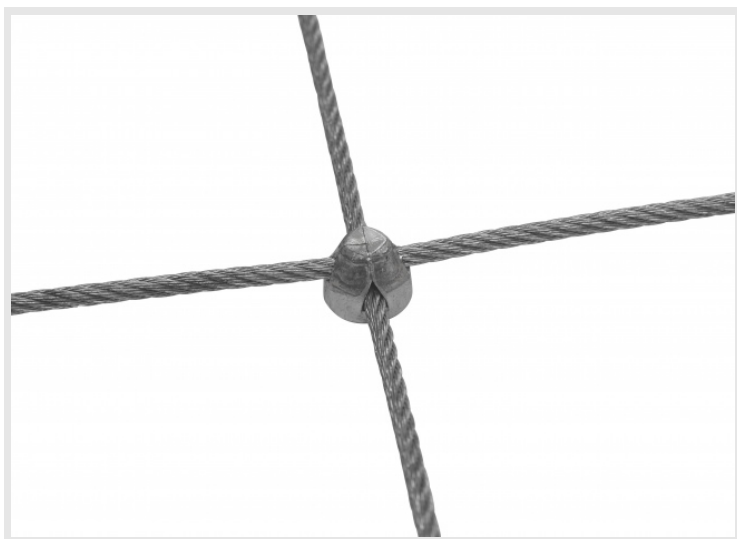

### TECHNICAL DATA

<b>Material</b>	stainless steel 1.4401, clamps made of aluminium
<b>Material Diameter</b>	Ø 2.5 mm
<b>Mesh Size</b>	50 x 200 mm
<b>Pose of Meshes</b>	rectangular
<b>Mesh Connection</b>	clamp-connection with four-wire connector
<b>Rope Construction</b>	7 x 7
<b>Edge Design</b>	loops
<b>Breaking Force</b>	minimum breaking force of rope: 3.9 kN
<b>Slip Resistance of Wire Connectors</b>	1.7 kN
<b>Continuous Operating Temperature</b>	-40 to +150 °C
<b>Weather-Resistance</b>	very good
<b>Electrical Characteristics</b>	electrically conducting
<b>Customs Tariff No.</b>	73129000
<b>Area Density</b>	500 g/m <sup>2</sup>