

Product Data Sheet Item No. 4630-050/200

Custom-made Steel Wire Net (by the m²)

Schutznetze24 GmbH
Weyerberg 5, DE-35614 Aßlar-Berghausen
Phone: +49 (0) 6443 - 436 96 40
Mail: office@safetynet365.com
Web: www.safetynet365.com

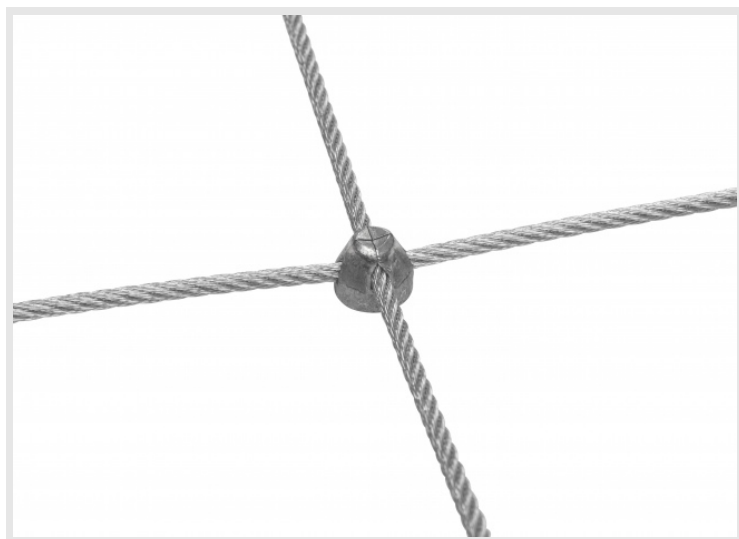

TECHNICAL DATA

Material	steel, galvanised, clamps made of aluminium
Material Diameter	Ø 3.0 mm
Mesh Size	50 x 200 mm
Pose of Meshes	rectangular
Mesh Connection	clamp-connection with four-wire connector
Rope Construction	7 x 7
Edge Design	loops
Breaking Force	minimum breaking force of rope: 6.1 kN
Slip Resistance of Wire Connectors	1.5 kN
Continuous Operating Temperature	-40 to +150 °C
Weather-Resistance	very good
Electrical Characteristics	electrically conducting
Customs Tariff No.	73129000
Area Density	700 g/m ²